

|||

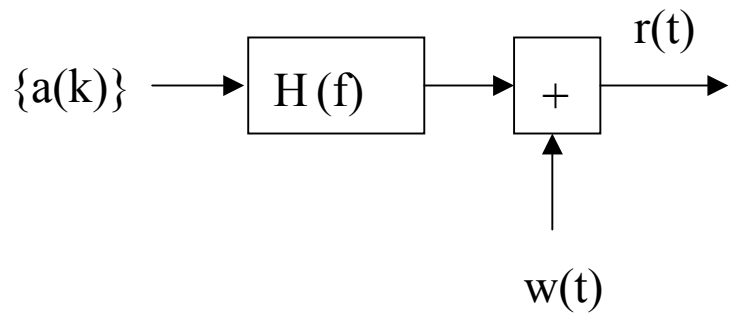

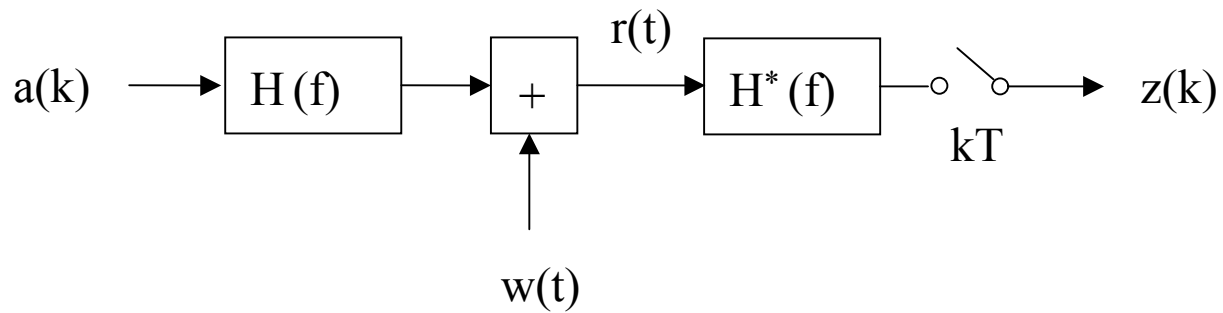

|||

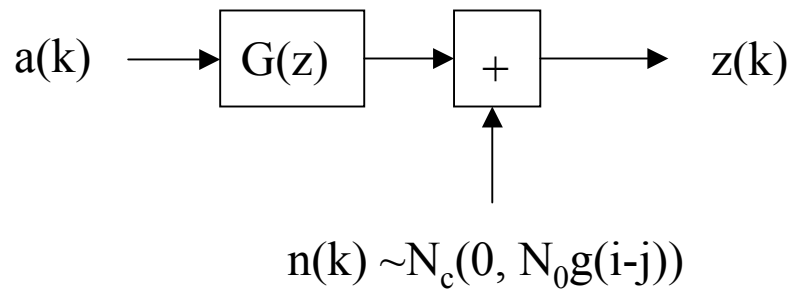

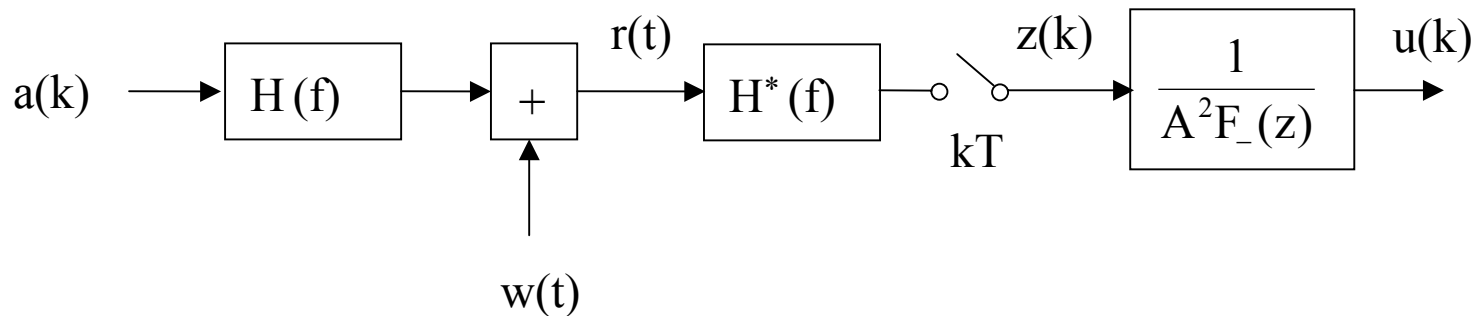

|||

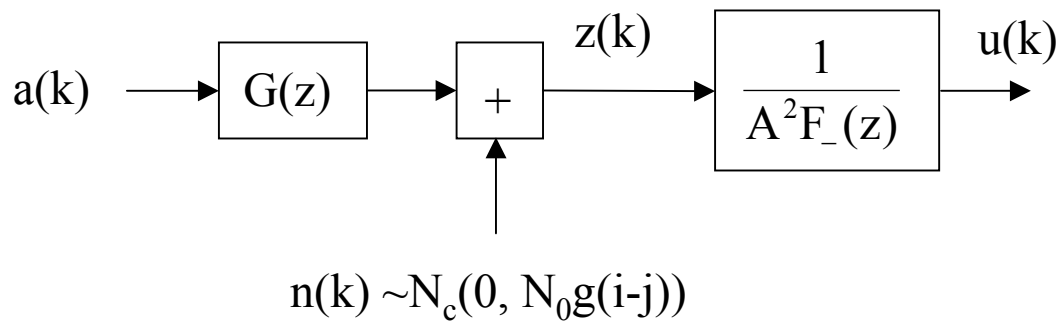

|||

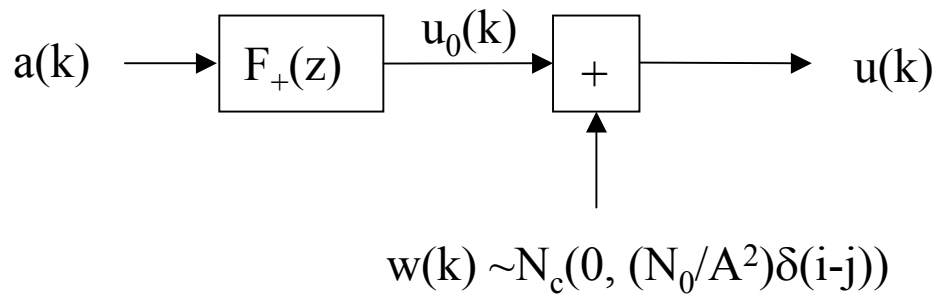

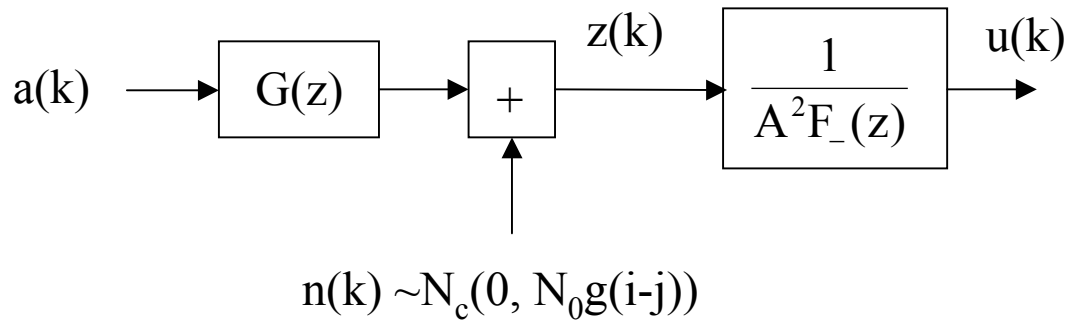

III

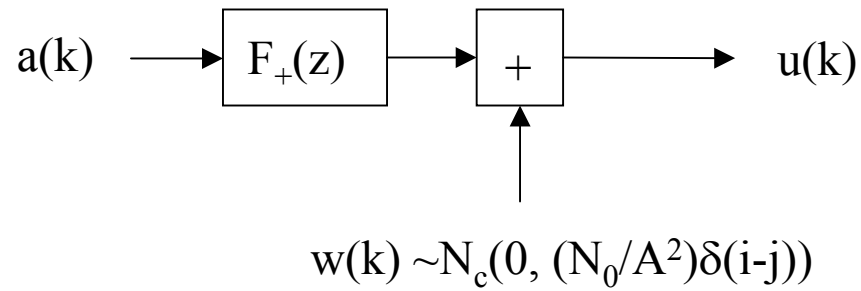

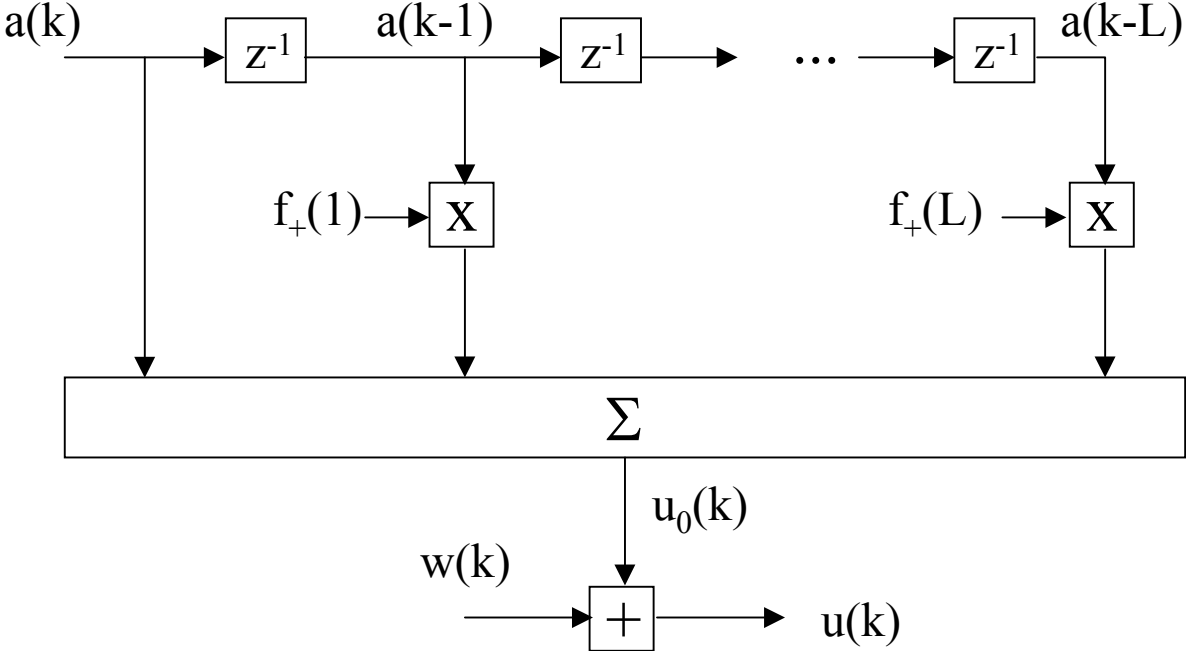

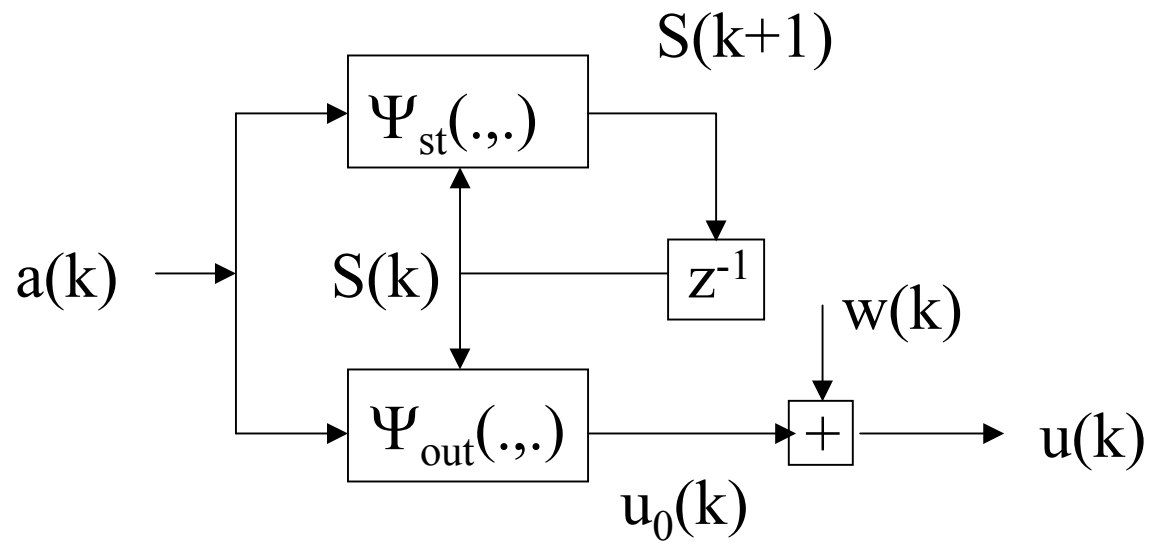

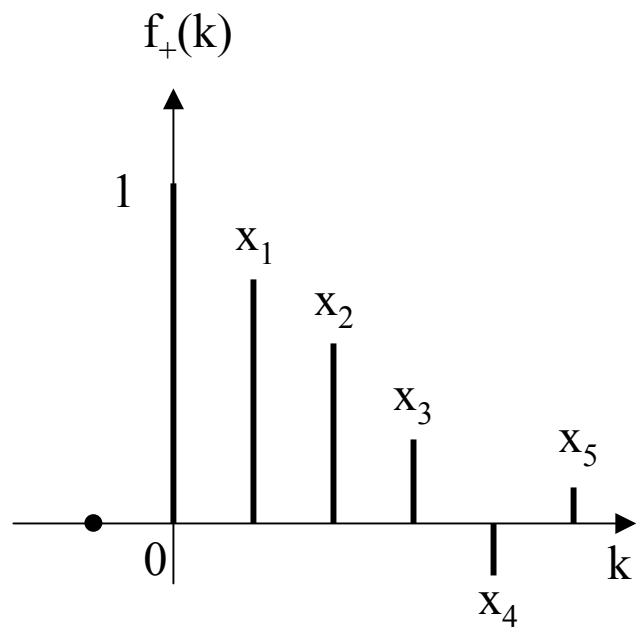
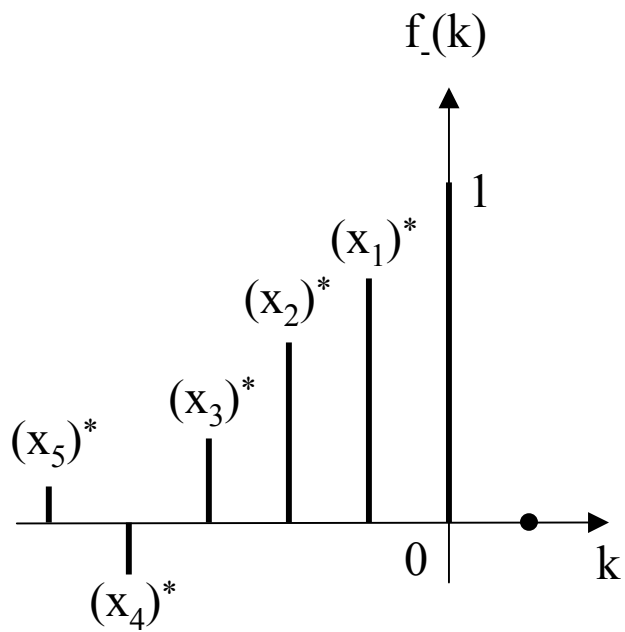

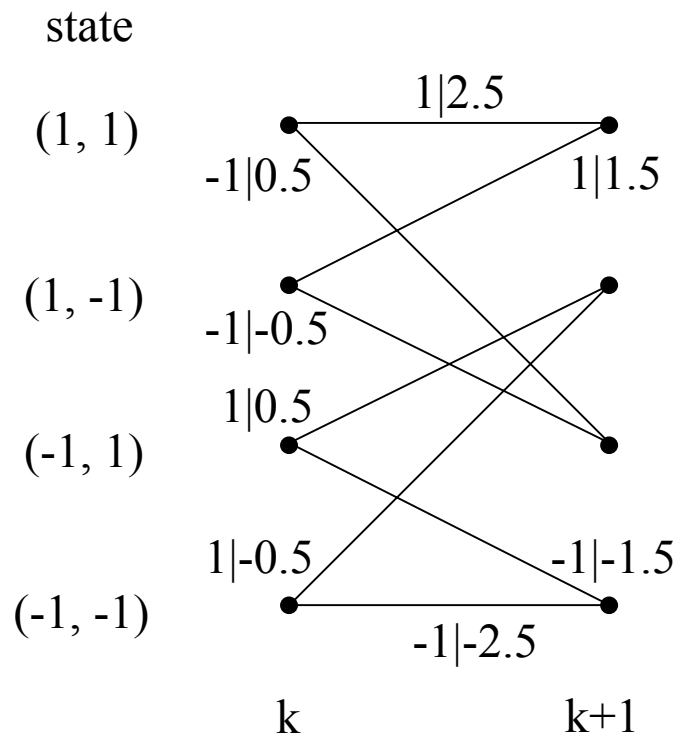



state

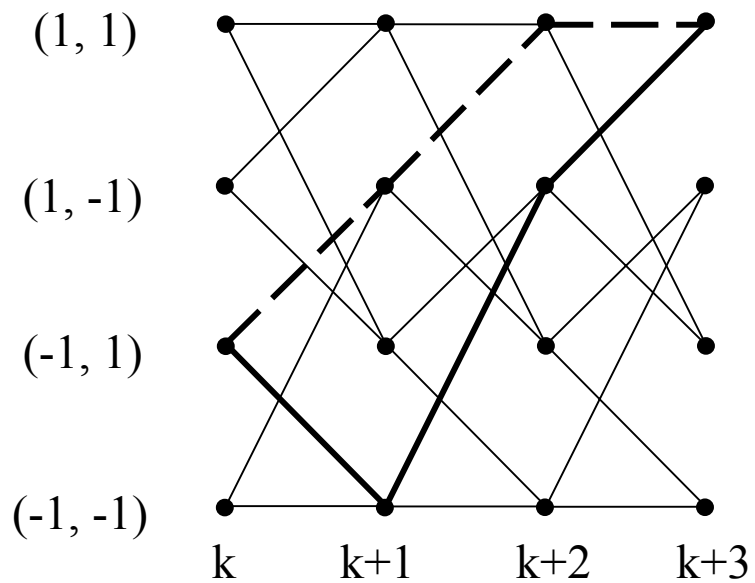

...

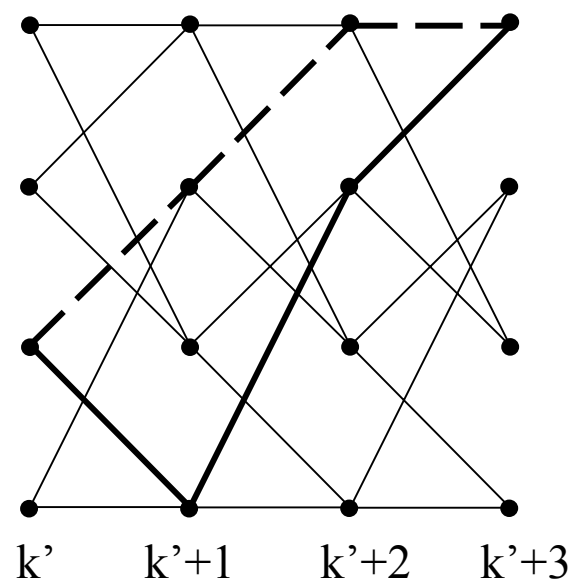

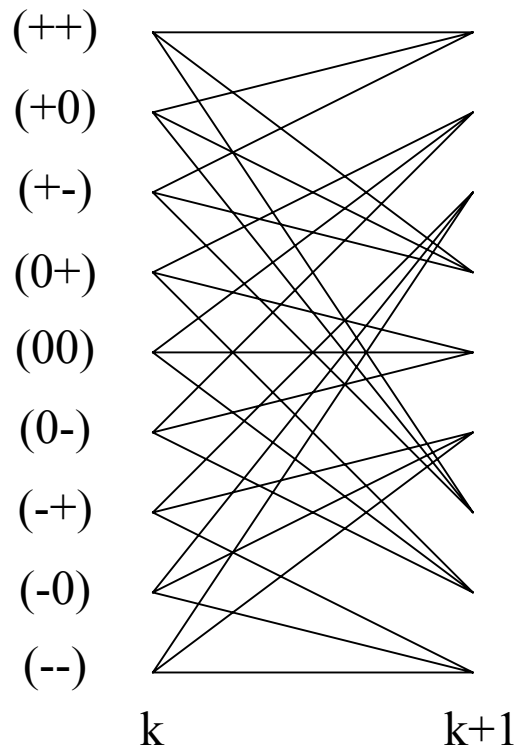

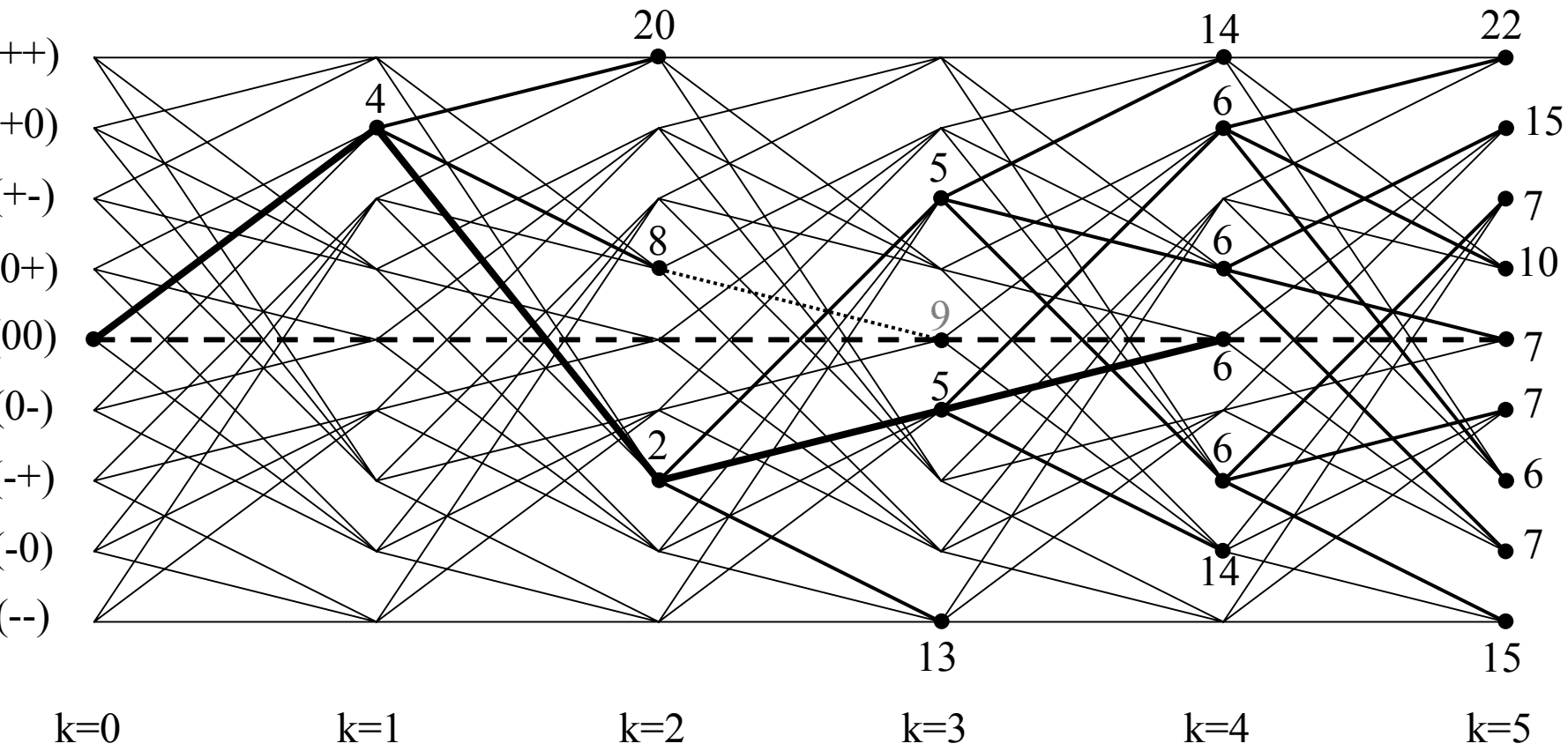

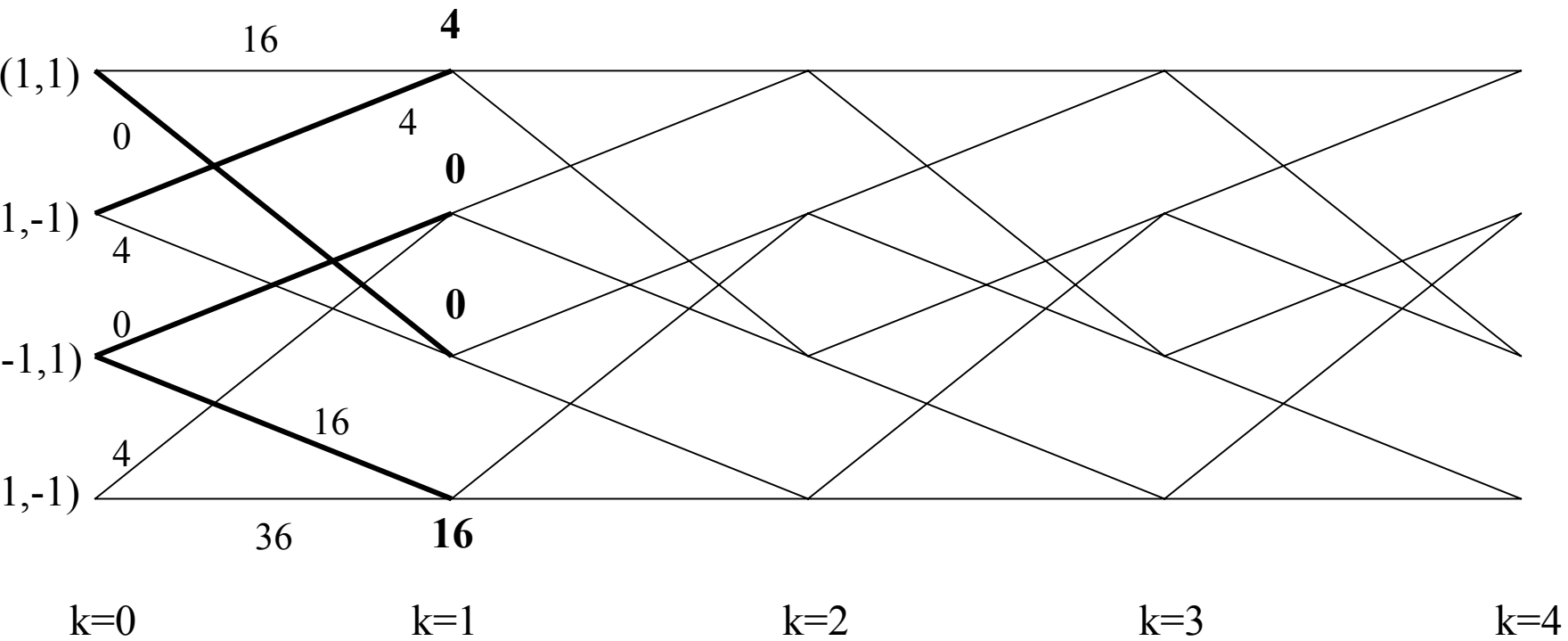

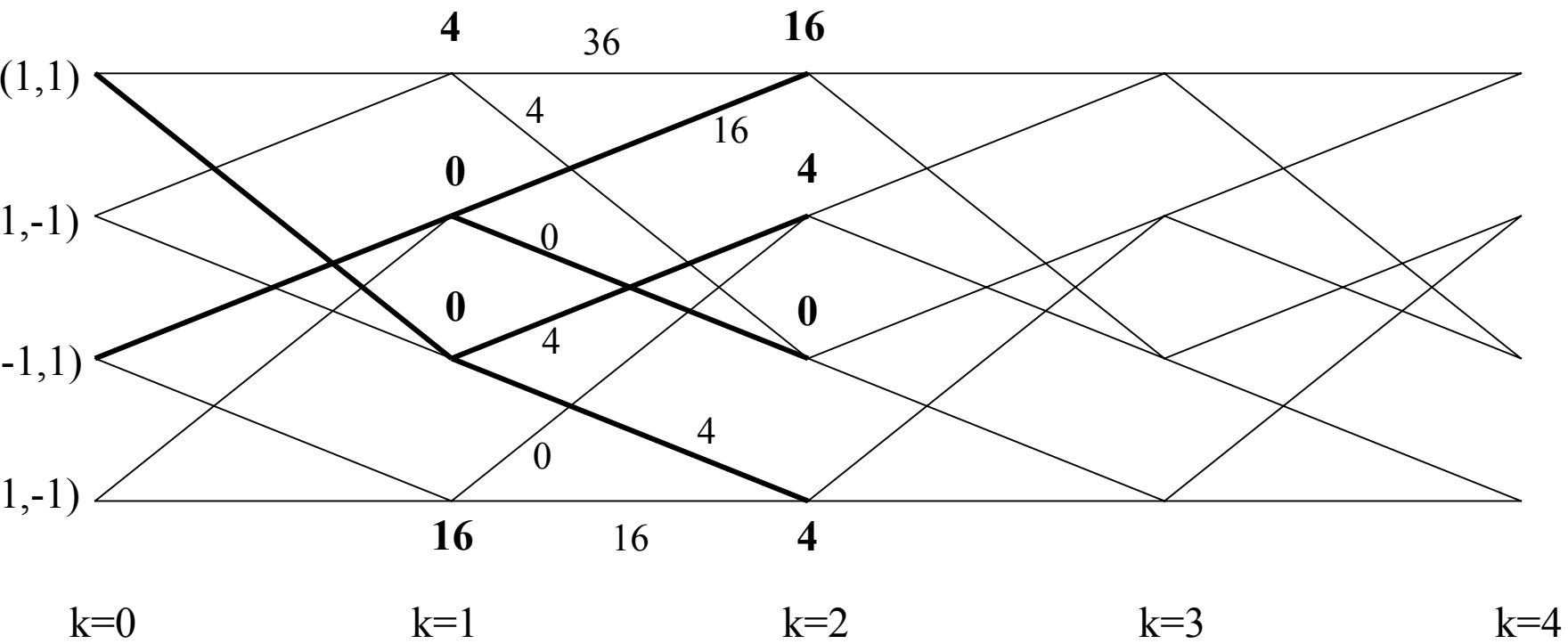

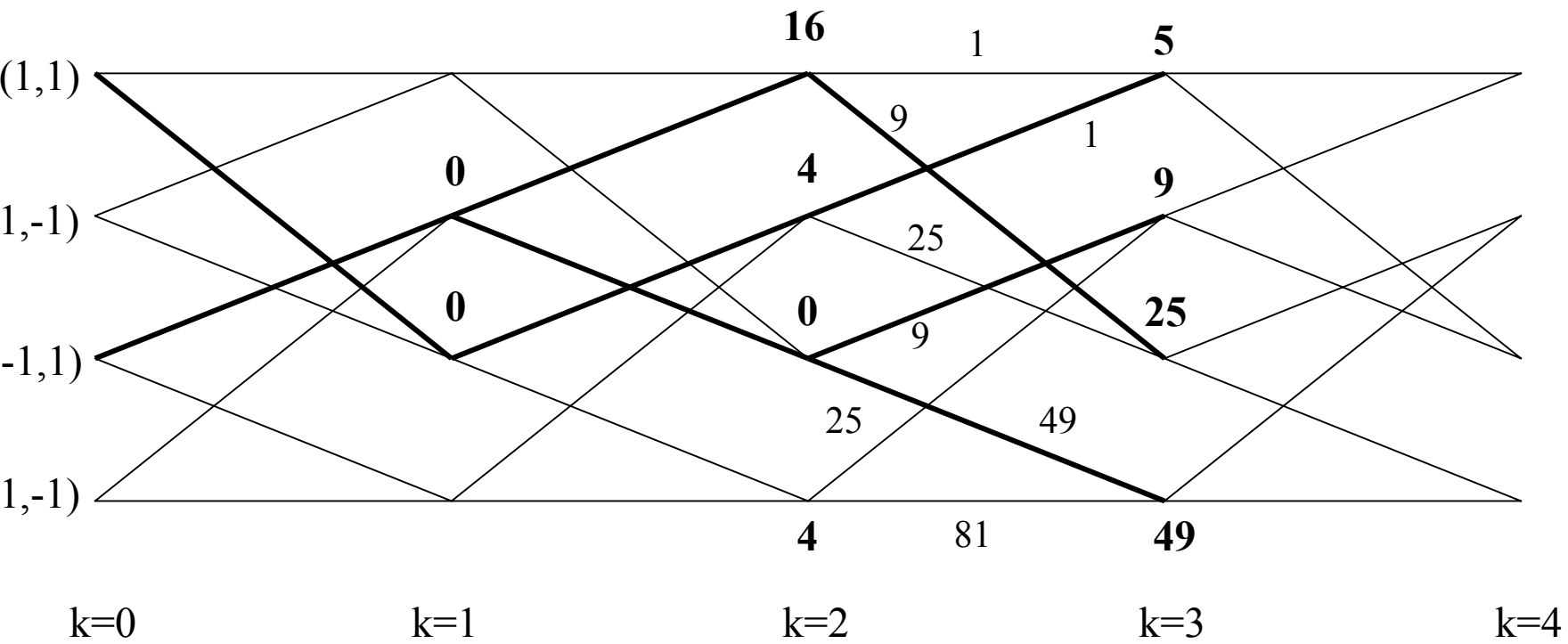

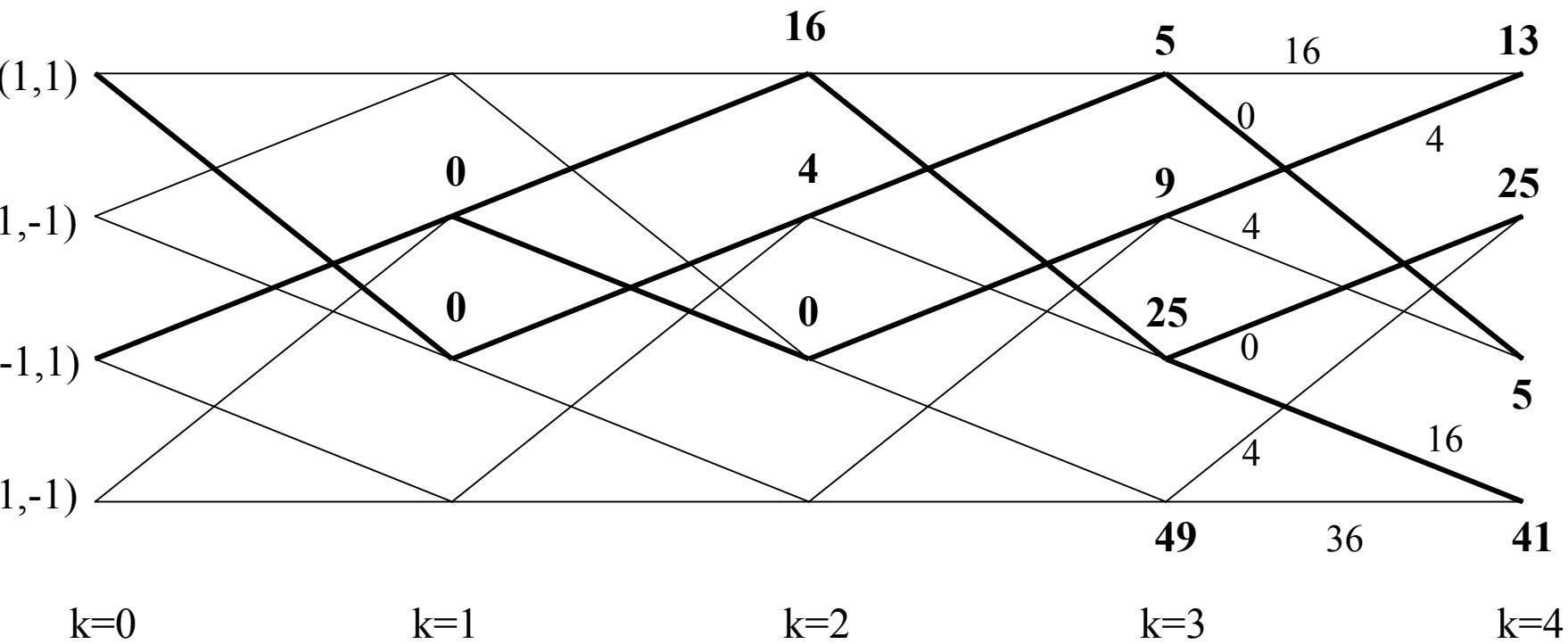

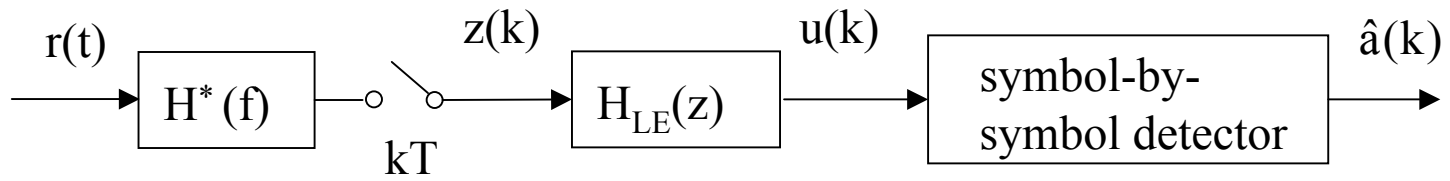



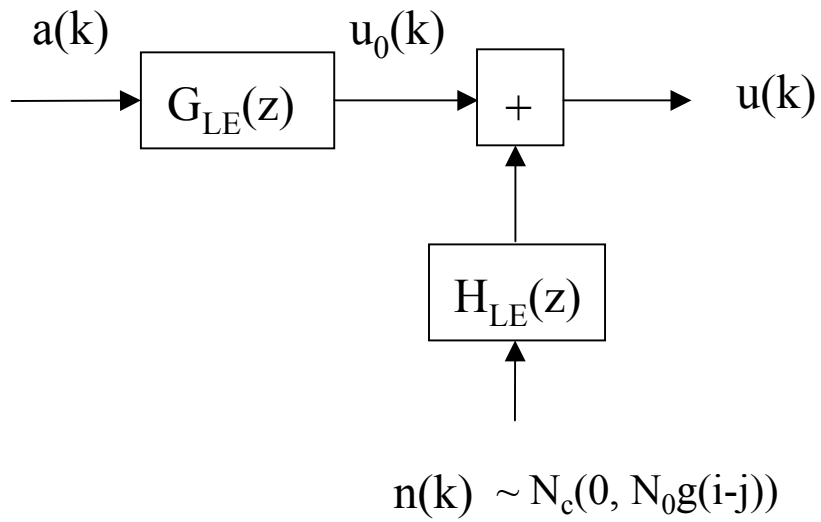

$w(t)$

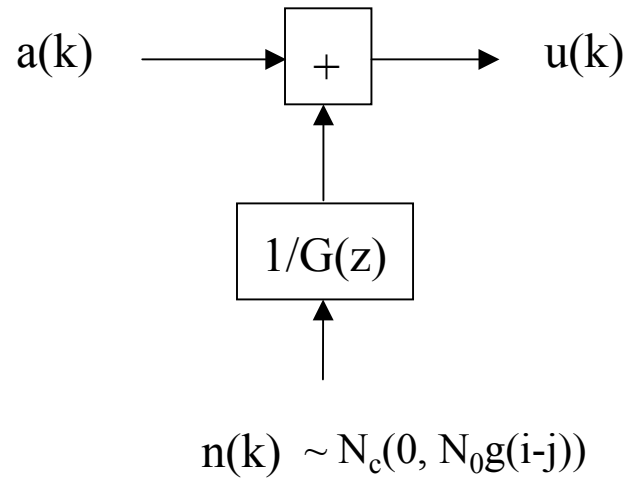

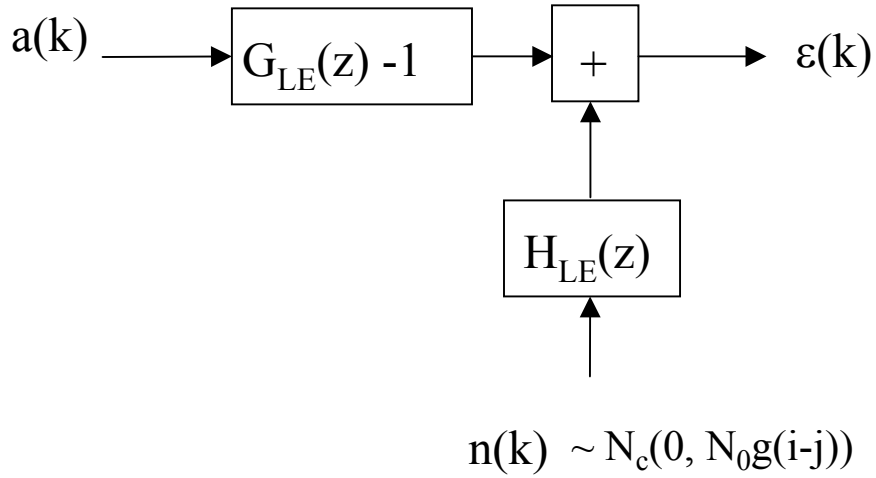

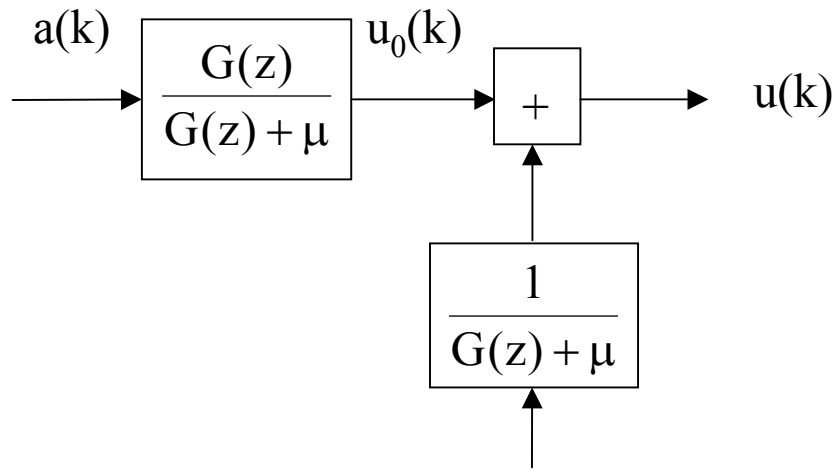

$$n(k) \sim N_c(0, N_0 g(i-j))$$

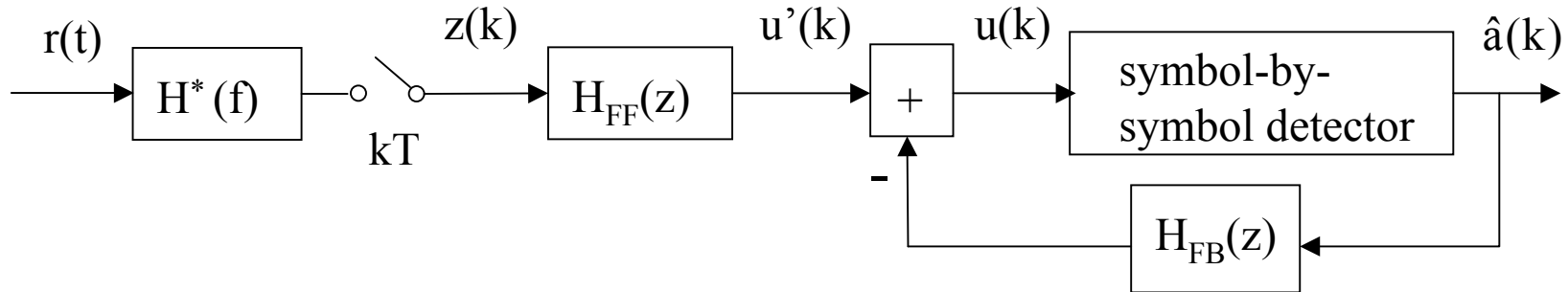

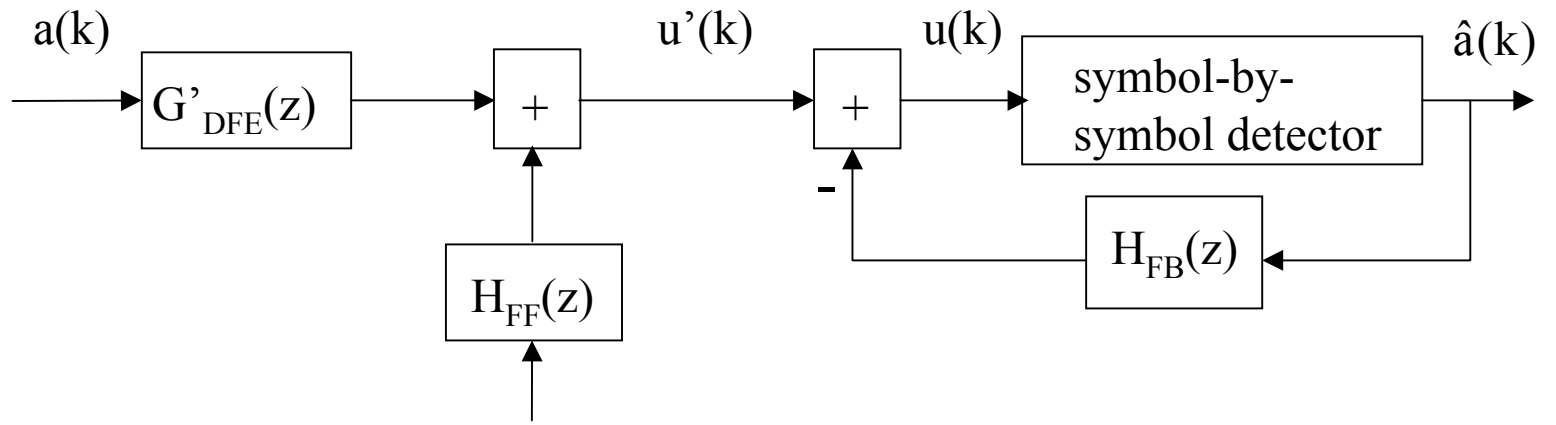

$$n(k) \sim N_c(0, N_0g(i-j))$$

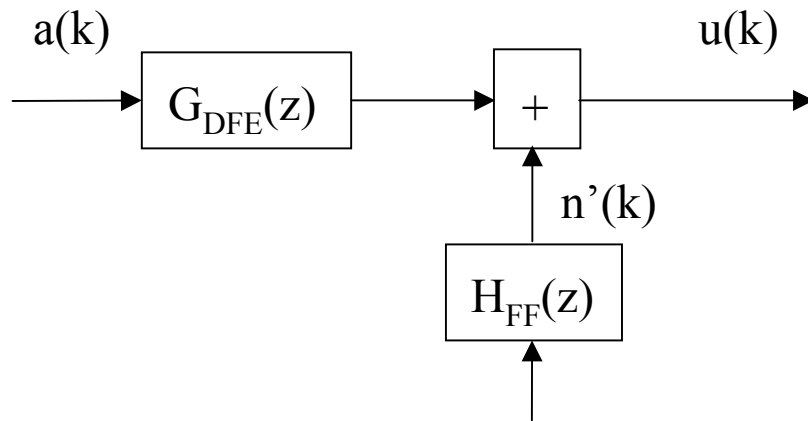

$$\mathbf{n}(k) \sim N_c(0, N_0\mathbf{g}(i-j))$$

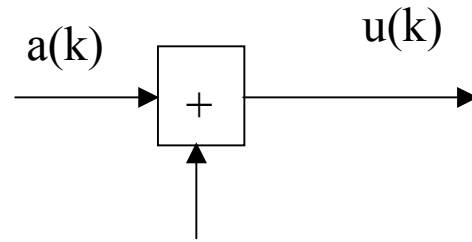

$$n'(k) \sim N_c(0, (N_0/A^2)\delta(i-j))$$



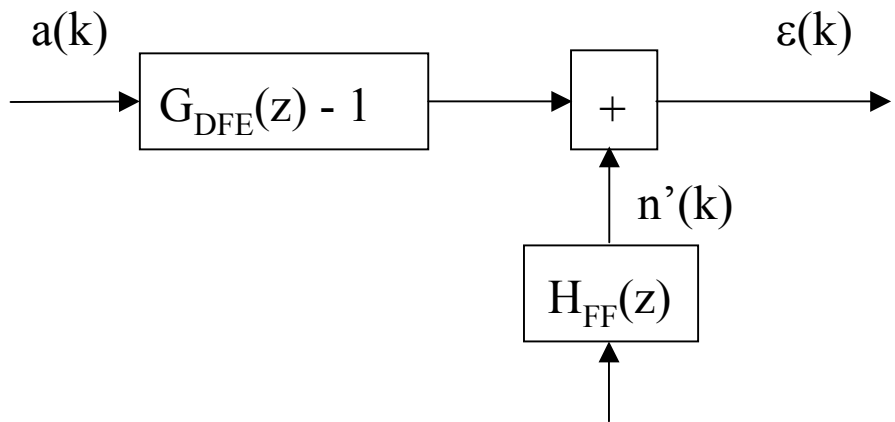

$$n(k) \sim N_c(0, N_0g(i-j))$$

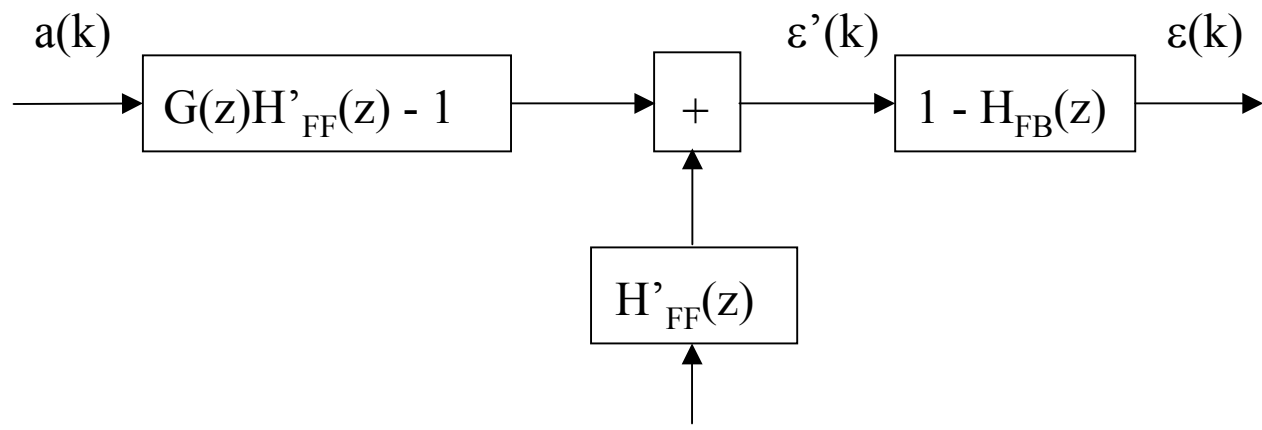

$$\mathbf{n}(k) \sim N_c(0, N_0\mathbf{g}(i-j))$$

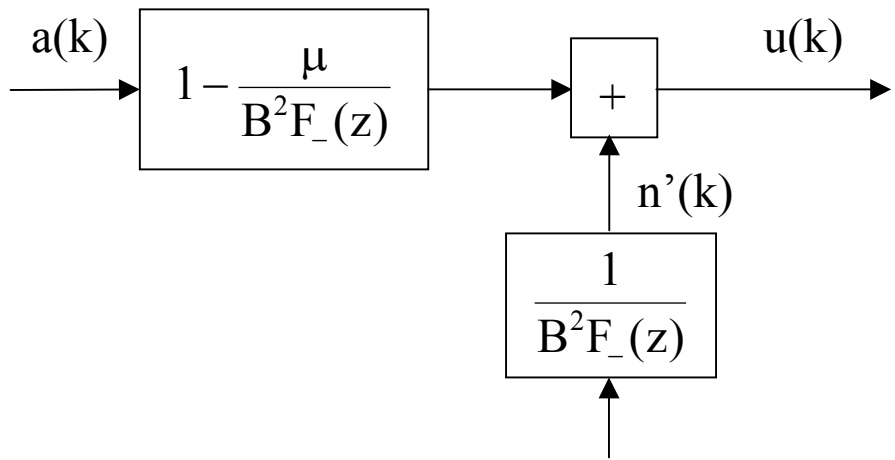

$$n(k) \sim N_c(0, N_0 g(i-j))$$

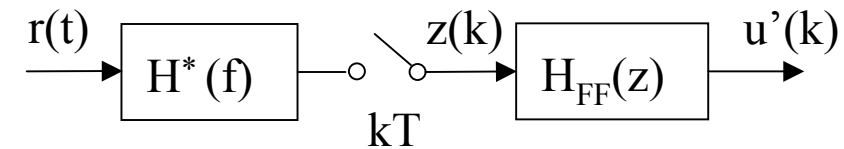

$\equiv$

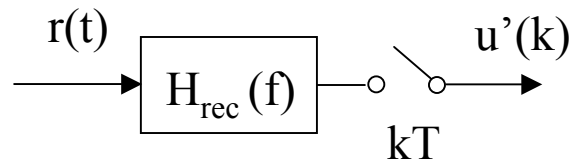

III

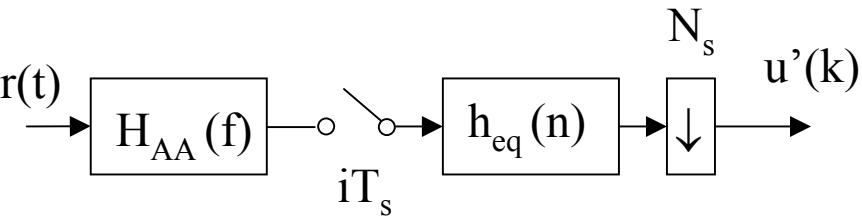

$\equiv$

